

VMI-Hybrid V2 Reminder & Error Codes Quick Reference Sheet

Consumables & Reminder Codes:

AW: = Add Water

- Please remove **Water Bottle** from back of the machine and fill it to the **250ml** mark.



Buffing Pads: 84 minutes of operation

CC: = Replace Buffing Solution & Clean Catch Tray

- Remove & replace **Buffing Solution** bottle with a new bottle. Remove, clean, and re-install **Catch Tray**



Center Hub: 84 minutes of operation

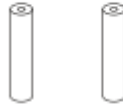

Jet Nozzle Extenders: 500 minutes of operation

CP: = Replace Buffing Pads & Centre Hub

- Remove & replace **Pads** with a new set. Remove & Replace **Centre Hub**.

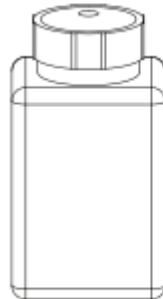

Water Bottle: 100 minutes of operation
Buffing Solution: 250 minutes of operation

RC: = Replace All Consumables

- Remove & replace **Pads, Buffing Solution Bottle, Centre Hub & Chip** with items from a new consumable pack.

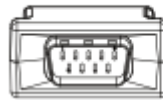

C-H Chip: 500 minutes of operation

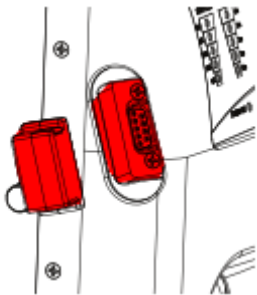

Install Chip

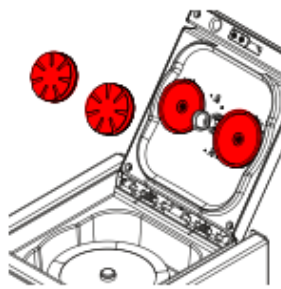

Install Pads

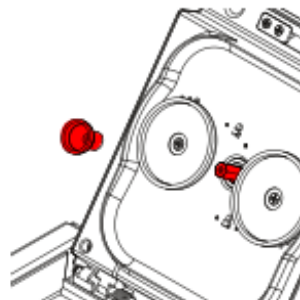

Install Centre Hub

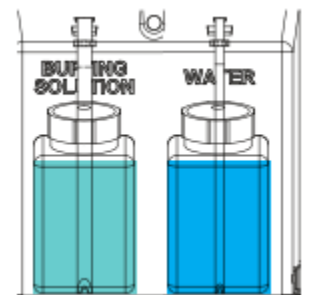

Install Water & Buffing Solution Bottles

VMI-Hybrid V2 – Error Codes:

*Note: To clear an Error/Reminder Code, please press the **Regular** button, followed by the **Blu-Ray** button.*

Error Code:	Description:	Solution:
E1	Top Cover Closed/ Switch Still Activated	Contact Reface Technical Support Team
E2	Main Motor detects insufficient pressure	Check Pads are installed correctly (“L” on Left-side and “R” on Right-side) Check Centre Hub is installed Check Water and Buffing solution nozzles are producing fluid (Press C & W buttons) Ensure Platen is installed
E3	Main Motor detects too much pressure	Check pads are installed correctly and well-seated in their holders Use your thumbs to press on pads and squash them down slightly
E4	Buffing Solution Pump is not working	Contact Reface Technical Support Team
E5	Water Pump is not working	Contact Reface Technical Support Team
ER	Emergency Stop activated	Pressing any button whilst the unit is running a cycle will cause this error Contact Reface Technical Support Team

